



HYDROGEN AND OXYGEN GENERATORS

OPERATING INSTRUCTIONS AND MAINTENANCE

GENERATOR L/45



Data featured on the machine identification plate:

Machine model:

Serial number:

Year of manufacture:

Machine delivery date:

For assistance, contact the following centre:

ELETTRONICA TODESCATO Srl

36057 Arcugnano (Vicenza) Italia - Via A. Volta, 9/A-C

Tel. +39 - 444 289227 - Fax +39 - 444 289229

www.elettronicatodescato.com - e-mail: info@elettronicatodescato.com

INDEX

SECTION 1: Description and main features of the welder

1.1	Presentation	4
1.2	Warranty	4
1.2.1	Exclusion from warranty	5
1.3	Machine identification	5
1.4	Equipment	7
1.5	Machine description and use limitation	7
1.5.1	Description	7
1.5.2	Use limitation	7
1.6	Noise	8
1.7	Technical features	9

SECTION 2: Safety and prevention

2.1	Safety	10
2.1.1	General safety regulations	10
2.2	Safety signs (Symbols)	11
2.3	Safe use and maintenance	12

SECTION 3: Transport and installation

3.1	Packaging	12
3.2	Shipping	12
3.3	Unpackaging	13
3.4	Positioning	13
3.5	Storing	13

SECTION 4: Use

4.1	Connection to the electric circuit	14
4.2	Preparing the electrolyte	14
4.3	Tank filling	14
4.4	Booster tank filling	15
4.5	Preparing deoxidizer liquid	15
4.6	Hazardous operations	16
4.7	Starting the machine	16
4.8	Stopping the machine	17
4.9	Backfire	17
4.10	Safety device	18
4.11	Refilling deoxidizer liquid	18
4.12	Refilling distilled or demineralized water	18

SECTION 5: Maintenance

5.1	Generalities	19
5.2	Every six months	19
5.3	Once per year	19
5.4	Every four years	20
5.5	Putting the machine out of service	20
5.6	Scrapping	20
5.7	Disposing of the electrolyte	20
5.8	Disposing of the liquid deoxidizer	20
5.9	Trouble shooting	21
5.10	Interventions	24
5.10.1	What to do in order to see if the tank is in short- circuit	24
5.10.2	Controlling pressure, adjustment valve	24
5.10.3	Checking valve tightness	25
5.10.4	Replacing the valve	25
5.10.5	Replacing the electrolyte	26

SECTION 6: Spare parts

6.1	Spare parts	26
-----	-------------	----

FIGURE LIST

Fig. 1	Welding and components	6
Fig. 2	Machine layout	9
Fig. 3	Safety signs	12
Fig. 4	Valve replacement	25
Fig. 5	Spare parts	27
Fig. 6	Wiring diagram	29
Fig. 7	Gas circuit	30

SECTION 1

Description and main features of the welder

1.1 PRESENTATION

This manual gives information regarded as necessary to know, use correctly and carry out normal maintenance operations on this welder « **L/45** » (hereinafter referred to as machine) fabricated by «**Elettronica Todescato S.r.l.**» di Arcugnano (Vicenza) Italy (hereinafter referred to as Manufacturer).

The material in this manual is not intended to be a complete description of the parts nor a detailed explanation of their option. The user, however, will find the kind of information normally required to operate the machine correctly and safely and also to keep in good working condition.

Compliance with and observance of what is described in the manual is an essential condition for the trouble-free operation, long life and cost effective performance of the machine.



ATTENTION

Failure to observe the instructions in this manual, negligence, incorrect or improper use of the machine can be cause of machine warranty coverage cancellation by manufacturer.

Manufacturer therefore declines any and all liability for injury to people or damage to property caused by failure to follow the instructions given in this manual.

Service work or overhauls involving complex operations must be entrusted to an authorized Technical Service Center which has the necessary specialized personnel, or directly to the Manufacturer who is at your complete disposal to ensure fast and complete technical assistance and anything else that can promote improved operation and optimal performance by the machine.



DANGER

This manual must be kept in a safe place at the disposal of the operator and service engineer, for consultation at any time during the machine's entire working life. It should be delivered with the machine if the latter is sold.

The manual must be kept in a safe place that is familiar to the assigned personnel. It is the responsibility of the personnel to keep the manual complete to allow for a consultation for the entire life of the machine. If the manual is damaged or lost, a copy must be immediately requested to the Manufacturer.

1.2 WARRANTY

Elettronica Todescato Srl ensures that the machine referred to in this manual has been tested in its own premises. The machine is guaranteed for 1 year (12 months) from the date of purchase. Should the machine be tampered with or improperly used, particularly concerning the safety devices, the warranty will be voided and the manufacturer will be discharged from any liability whatsoever.

Upon delivery, make sure that the machine has not suffered damage during transportation and that it is complete with all standard accessories and any optional equipment specifically ordered. Complaints must be written and submitted to your reseller within and not later than 8 (eight) days.

1.2.1 EXCLUSIONS FROM WARRANTY

This warranty shall be null and void (apart from the causes given in the Purchase Contract):

- If the machine is used with incorrect voltage.
- If the damage is due to insufficient maintenance or lack of proper service.
- If, following repairs carried out by the owner without manufacturers consent due to installation of non-original spare parts, the machine has been changed and the damage was caused by these changes.
- If the instructions given in this manual were not followed correctly.
- Exceptional events.

Damage caused by negligence, lack of care, improper and bad use of the machine or incorrect maneuvering by the operator shall also cause this warranty coverage to be null and void.



ATTENTION

Removal of safety devices installed on the machine will automatically make this warranty null and void of the Manufacturer.

1.3 MACHINE IDENTIFICATION

Each machine is equipped of identification plate (fig.1 # 21), giving the following information:

- Name and address of **Manufacturer**;
- «**CE**» mark;
- **A)** Machine type;
- **B)** Year of fabrication;
- **C)** Serial number;
- **D)** Voltage;
- **E)** Ampere;
- **F)** Watt;
- **G)** Frequency;
- **H)** Pressure.

The data given on the identification plate should be written in the spaces provided on the back cover of this manual and should always be specified when ordering spare parts or requesting Technical Assistance.

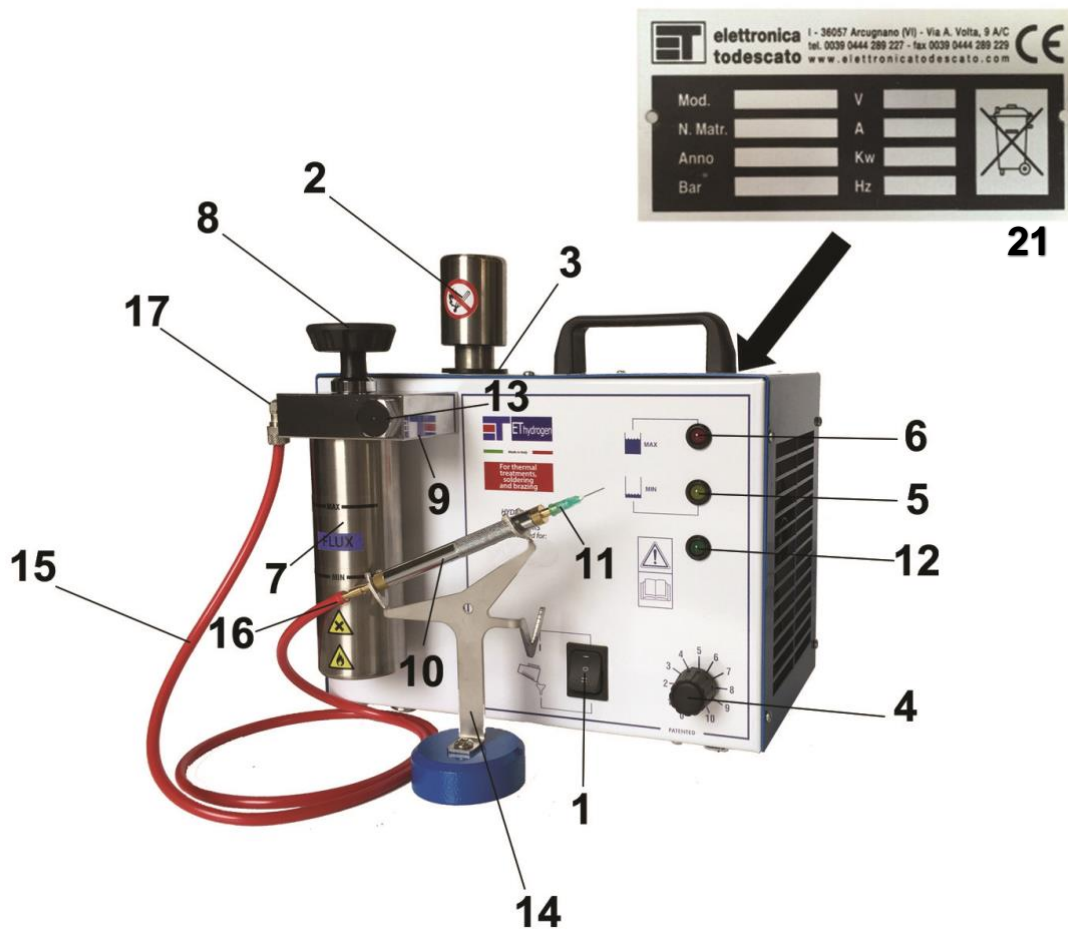

FIG. 1- WELDER AND COMPONENTS

Legend Fig.1

- | | |
|---|---------------------------------|
| 1. Three-position switch | 10. Torch |
| 2. Safety cap | 11. Burner tip |
| 3. Filling neck | 12. On indicator light (green) |
| 4. Power control knob | 13. Check valve cap |
| 5. Minimum level indicator light (yellow) | 14. Torch holder (optional) |
| 6. Maximum level indicator light (red) | 15. Torch hose |
| 7. Booster Tank | 16. Torch hose fitting |
| 8. Handle knob | 17. Booster holder hose fitting |
| 9. Booster holder | 21. Identification plate |

1.4 EQUIPMENT

Standard equipment

- Burner tip (Fig. 1 # 11).
- User manuals and DVD.
- Spare fuse (Fig. 5 # 37).
- Plastic funnel.
- Torch (s).
- Fire proof rubber hose.
- Power cord.

Optionals:

- Container with distilled / demineralized water.
- Container with liquid flux (deoxidizer).
- Torch holder (14 Fig. 1).
- 2.5 Bar pressure gauge.
- Electrolyte solution.
- One year maintenance kit.
- Ignitor.

1.5 MACHINE DESCRIPTION AND USE LIMITATION

The «**ET- hydrogen L/45 Welder** is a machine marked with «**CE**» symbol in compliance with European Union regulations pursuant to EEC Directive 2014/35/UE and 2014/30/CE as detailed in the UE Declaration of Conformity annexed to each machine.

1.5.1 DESCRIPTION

The «**ET Hydrogen Welder L/45**» can be used in craftwork or industrial workshop with a minimum volume of 30 m³ and provided with natural ventilation by means of suitable openings to the outside in compliance with the regulations in force in the user's country. This machine is mainly used for soft and hard brazing applications in the fields of jewellery, goldsmith, costume jewellery, dental mechanics, micromechanics, and for welding materials such as platinum, beryl, nickel, thermocouples, enamel copper, glass, quartz and for welding metal to metal and applicable for welding in industry, within the limitations of the machine.

1.5.2 USE LIMITATIONS

The hydrogen and oxygen mixture produced by this welder must be solely used to produce one flame for braze welding or thermal treatments of metal parts in general, or for working quartz glass.



DANGER

Any use different from those quoted here within and not included or not directly inferred from this instructions' manual, will be regarded as «NOT ALLOWED».

It is not permitted to operate the machine when the flame is out. This would result in an accumulation of explosive mixture in the surrounding environment and pollution caused by the methyl alcohol.

The machine has been designed for professional use. The operator must be of proven ability and capable of reading and understanding the instructions given in this manual.

The operator must also use the machine in accordance with the ruling accident prevention standards, operating conditions and characteristics of the machine.



DANGER

THE USE OF THE MACHINE FOR ANY OTHER PURPOSE THAN THAT DESCRIBED IN THIS MANUAL RELIEVES THE MANUFACTURER OF ANY RESPONSIBILITY FOR DAMAGES TO PERSONS, ANIMALS OR THINGS RESULTING FROM INAPPROPRIATE USE.

1.6 NOISE

The noise level (acoustic pressure) was determined with the machine running under no load conditions with the readings of the 70 dB(A) inferior.

1.7 TECHNICAL FEATURES



FIG. 2- MACHINE LAYOUT

H₂/O₂ Gas production	lt/h	45
Water consumption	cc/h	22
Alcohol consumption	cc/h	9
Booster tank capacity	cc	153
Maximum power	Watt	280
Electrolyte	L	0,5
Weight	Kg	14

SECTION 2

Safety and Prevention

2.1 SAFETY

The owner of the machine must instruct personnel about the risk of industrial accident, the safety device installed for operator safety and on general industrial accident prevention regulations applied by law in the country where the machine is to be operated.

Operator safety is a matter of considerable importance for machine design and fabrication. When designing a new machine, every effort is made to foresee every possible dangerous situation and, naturally, adopt suitable safety devices to counter them. Therefore, a careful reading of this manual and special care and attention whenever any intrinsically operations have to be carried out are obligatory.



DANGER

Manufacturer declines any and all liability for injury to people or damage to things caused by failure to follow this safety regulation and accident prevention recommendations detailed here.



Pay further attention when you see this symbol in the manual.

2.1.1 GENERAL SAFETY REGULATIONS



ATTENTION

Failing to comply with the information described in «Section 2 – Safety and Prevention» and the mishandling of the safety devices relieves the Manufacturer from any responsibility in the event of accidents, damage or machine malfunctions.

General rules:

- The user undertakes to entrust the machine to qualified and trained personnel only.
- The user is bound to take all the necessary measures for preventing unauthorized personnel from accessing the machine.
- The user undertakes to provide its personnel with adequate information regarding the application and observance of the safety regulations. To this end, the user undertakes to ensure that all the personnel understand the machine operating instructions and the safety regulations relative to their particular responsibility.

- The user must inform the Manufacturer of any defects or malfunctions in the accident prevention system and any situations of potential danger.
- The personnel must use the personal protection items provided for by law and respect instructions given in this manual.
- The personnel must respect the danger and caution symbols on the machine.
- The personnel must not perform operations or interventions under their own initiative that lie outside their competence.
- The personnel is obliged to notify superiors of any problem or dangerous situation that may arise.
- The machine has been commissioned and tested with all the parts included within the standard equipment. The installation of parts or other makes or modifications to the machine may vary its characteristics and compromise its operating safety.
- The machine must only be used for the purpose for which it was constructed.

2.2 SAFETY SIGNS (Symbols)

During the construction of machine, all the possible solutions for the safety the operator have been adopted. The machine may nevertheless present ulterior risks which have not been possible to eliminate completely under certain operating conditions. These risks have been highlighted on the machine with adhesive warning symbols that indicate the various situations of reduced safety or danger.



ATTENTION

Keep the safety stickers clean and replace them immediately if they are peeling away or are damaged.

The following warnings refer to Figure 3. Read them carefully and learn their meaning.

- 1) **Excessive voltage. Before interventions, disconnect power.**
- 2) **Toxic substance, if swallowed. Do not inhale the vapours.**
- 3) **Easily flammable.**
- 4) **Corrosive liquid when in touch with body members.**
- 5) **Attention, electrostatic discharge sensitive device.**
- 6) **Flammable. Do not approach free flames.**
- 7) **Use protection glass.**
- 8) **Use protection mask for respiratory tract.**
- 9) **Use protection gloves.**
- 10) **Before using the machine, read the operating instructions carefully.**
- 11) **Attention, do not turn the handle knob while the flames are lit.**



FIG. 3 – SAFETY SIGNS

2.3 SAFE USE AND MAINTENANCE



ATTENTION

- The use of the machine is prohibited to:
 - o Operators who have not read and understood the instructions given in this manual;
 - o Inexperienced persons;
 - o Operators not in good physical/mental health.
- Periodically check that the machine and its protection devices are in perfect working order.
- Before maintenance operations or repairs on the machine, disconnect power.
- Maintenance operations and repairs must only be carried out by personnel trained to perform these special functions.
- At the end of the maintenance operations and repairs, before restarting the machine, the technical foreman must check that the work has been finished, the safety device reactivated and the protections reassembled.
- The spare parts must correspond with those stipulated by the Manufacturer. Only use original spare parts.
- During maintenance operations and repairs, protective clothing must be worn, i.e. protective eyewear, gloves for preventing cuts and mask for respiratory tract protection.
- Do not use water jets to clean the machine.

SECTION 3

Transport and Installation

3.1 PACKAGING

The welder is wrapped up in a polythene film and subsequently packed in a three-layer waterproof cardboard box sealed with adhesive tape and secured by a double strap.

3.2 SHIPPING

Whatever transportation method is used, (either by plane, sea or land) continental or intercontinental, the machine tanks will be empty.

If **REQUESTED** or where **PERMITTED**:

The packaged electrolyte salts and/or bottled demineralized water, will be shipped according to the rules, law and regulations of the machine's destination (country).

3.3 UNPACKAGING

Make sure that:

- The welder has not suffered damage during transportation and, if necessary, report to the manufacturer or authorized reseller.

3.4 POSITIONING

Set the welder on a solid and stable surface, away from heat sources. Allow at least 50 cm of free space for the cooling louvres on the machine sides, for proper air circulation.

3.5 STORING

When the welder is in storage, the tank must be filled with electrolyte (Fig.5 # 46) and the machine must be started for a few minutes at least once a month.

Avoid storing in humid places.

SECTION 4

Use

4.1 CONNECTION TO THE ELECTRIC CIRCUIT

Check that the main voltage corresponds to the voltage indicated on the plate at the rear of the welder (Fig. 1 # 21). Test the electrical circuit grounding to make sure that it is efficient.

- Slide the switch (Fig.1 # 1) to the “O” position.
- Insert power cable plug (Fig.5 # 31) into the current outlet.

4.2 PREPARING THE ELECTROLYTE

Pour **180 grams of KOH (Potassium Hydroxide)** into a clean stainless-steel vessel and/or hard plastic container that has been previously filled with 0,445 liters (0.118 US gal) of distilled or demineralized water. If the vessel needs to be cleaned, wash it with tap water a few times, until it becomes clean and after that, dry it with a rag. Stir immediately but gently, using a clean stainless-steel implement, until the product is fully dissolved, producing a reaction that generates heat. Wait until the solution has cooled down. **DO NOT USE DETERGENTS OR LIQUID SOAPS.**

DO NOT PREPARE the electrolyte solution inside the machine tank. It must be prepared into an external vessel **BEFORE** being introduced inside the machine tank.



DANGER

AVOID SPILLS. ALLOW COOLING TIME.

THE ELECTROLYTE IS HIGHLY CAUSTIC AND CAN CAUSE SERIOUS SCALDS TO THE SKIN AND HUMAN BODY. WHEN HANDLING THIS PRODUCT, ALWAYS MAKE SURE THAT A CONTAINER FULL OF WATER AND VINEGAR IS WITHIN REACH, IN ORDER TO BE ABLE TO WASH IMMEDIATELY ANY PART THAT COMES INTO CONTACT WITH THE PRODUCT AND SUBSEQUENTLY RINSE CAREFULLY WITH RUNNING WATER.

THE USE OF PROTECTIVE CLOTHES, GLOVES, GLASSES, MASK FOR RESPIRATORY TRACT, IS OBLIGATORY.

IF THE PRODUCT COMES INTO CONTACT WITH THE EYES, WASH AND RINSE THEM REPEATEDLY AND IMMEDIATELY, THEN TAKE THE AFFECTED PERSON TO A FIRST AID STATION.

4.3 TANK FILLING



- 1) Slide the switch (Fig.1 # 1) to the “=” position; the green indicator light (Fig.1 # 12) and the “MIN” yellow indicator light (Fig.1 # 5) on the control panel will be illuminated.
- 2) **BEFORE ANY RE-FILL OPERATION, REMOVE THE BOOSTER TANK (FLUX) ALWAYS FIRST, (Fig 1 # 7).**
- 3) Remove the safety cap (Fig.1 # 2).

- 4) Through the use of a funnel, slowly pour the electrolyte previously prepared through the filling neck (Fig.1 # 3) and into the tank (Fig.5 # 46). The “MAX” yellow light (Fig.1 # 5) will go out. If the “MAX” red light (Fig.1 # 6) does not shine after all the electrolyte has been poured into the tank, add distilled or demineralized water until the light is illuminated.



IT IS RECOMMENDED THAT NO WATER IS POURED WHEN THE RED LIGHT IS ON.

- 5) Put the safety cap back into place (Fig.1 # 2) and tighten it. Do not over tighten.
- 6) Slide the switch (Fig.1 # 1) to the “O” off position.

IMPORTANT NOTE:

For the first startup of our ET systems, or for the yearly maintenance (once every year), the machine must be filled or refilled with electrolyte solution.

For the daily refill it is mandatory to pour only demineralized (or distilled) water inside the electrolyte tank

Pouring electrolyte solution daily will cause a crystallization inside the tank and consequent obstructions of machines’ hoses, potentially causing a general malfunction.

4.4 BOOSTER TANK FILLING

- 1) Loosen the handle knob (Fig.1 # 8) and remove the Booster Tank (Fig.1 # 7).
- 2) Pour the deoxidizer liquid (see sec. 4.5) into the Booster Tank until it reaches the “MAX” marked on the outside. Do not pour liquid beyond this level.
- 3) The eventual electrostatic charge of your body may cause **a spark and flame up the liquid deoxidizer**, this is to be avoided. Therefore take a moment to discharge your electrostatic charge on another metal object before approaching the Booster Tank. Before approaching the Booster Tank while on its seat, you touch, for a moment with the other hand, the Booster holder (Fig.1 # 9). Repeat this operation each time you perform the Booster filling deoxidizer.
- 4) Place the Booster Tank back into place (Fig.1 # 7) and tighten the handle knob (Fig.1 # 8), just enough. Do not overtighten in order to preserve the gaskets’ integrity.

4.5 PREPARING FLUX (DEOXIDIZER) LIQUID.



METHYL ALCOHOL IS BOTH FLAMMABLE AND TOXIC. HANDLING MUST TAKE PLACE AWAY FROM FLAMES, SPARKES AND HEAT SOURCES. IN GENERAL AVOID CONTACT WITH THE MOUTH AND AVOID INHALING ITS VAPORS.

By dissolving boric acid with methyl alcohol (as explained hereunder) you will obtain a green flame with high deoxidizing power, that is indispensable for braze welding operations, since it ensures optimal flow and penetration of the solder. In the thermic treatments, methyl alcohol is normally used in its pure state.

- 1) Pour the desired quantity of methyl alcohol into a plastic container provided with hermetic seal cap.
- 2) Add the boric acid in the form of flakes in a proportion of 15- 20 grams. (as a maximum) per each liter of methyl alcohol.
- 3) Close the container, shake it up and wait until the product is fully dissolved, before using.

4.6 HAZARDOUS OPERATIONS



DANGER

When the flames are burning:

- **Do not unscrew the handle knob screw (Fig.1 # 8).**
- **Do not unscrew the Safety Cap (Fig.1 # 2).**
- **Do not bring flames or sparkles near the filling neck, the safety car and booster tank/booster holder (Fig.1 # 2, 3, 7, 9).**
- **Do not introduce metal objects inside the tank (Fig.5 # 46).**

4.7 STARTING THE MACHINE

- 1) Connect the welder to a current outlet.
- 2) Mount the burner tip onto the torch cone by screwing it and pushing it into place, until it is tight enough (Fig.1 # 11).
- 3) Set the power control knob (Fig.1 # 4) according to the indications shown in Table 2.
- 4) Slide the switch (Fig.1 # 1) to the “ - “ position. The green indicator (Fig.1 # 12) and red indicator (Fig.1 # 6) will be illuminated.
- 5) Wait for approximately two minutes, until you hear/feel the emission of gas from the burner tip (Fig.1 # 11).
- 6) Light the torch with a standard lighter or an electronic igniter.
- 7) Clean the orifice (Fig. 1 # 11) with a thin steal wire or other similar safe object, in order to not cause personal harm or damage the burner tip. You may also put the burner tip in luke warm water for the cleaning of the orifice.



NUMBER OF TORCHES	BURNER TIP EXTERNAL DIAMETER			POWER ADJUSTMENTS	
				Min	Max
1	Ø 0.6 mm/0.0236 inch		VIOLET	1	8
1	Ø 0.7 mm/0.0275 inch		BLACK	3	9
1	Ø 0.8 mm/0.0314 inch		GREEN	6	10

TABLE 2

**DANGER**

You can adjust the flames by operating on the power control knob (Fig.1 # 4) which regulates the power and then consequently the flame. This should be set within the limit values presented, see TABLE 2. Setting the power level below the minimum value allowed would cause a pressure drop that would melt the burner tip, resulting in back fire in the Booster Tank.

4.8 STOPPING THE MACHINE

To turn off the welder, you must perform the following operations:

- 1) Put out the flame by rapidly pushing the base of the torch into a click motion. (Fig. 1 #16) (Fig. 1 #10).

**DANGER**

If this operation is performed slowly, it can result in backfire.

- 2) Slide the switch (Fig. 1 # 1) to the “0” position. (off)

**ATTENTION**

After turning off the machine and awaiting the necessary cooling time (approx. 5 hours), do not unscrew the safety cap. If this should happen, tighten it back and start the machine for 30 seconds, with the power control knob (Fig. 1 # 4) set on the maximum value.

**ATTENTION****4.9 BACKFIRE**

Backfire can occur for the following reasons:

- When putting the flame out and the base of the torch is pushed too slowly. This operation should be done rapidly, as described above.
- The burner tip diameter is different from the diameter recommended in Table 2.
- The gas delivery is insufficient, due to wrong power setting.
- Failure in the welder electric circuit.
- Lack of voltage in the supply channel.
- Insufficient amount of deoxidizer or Booster Tank (Fig. 1 # 7) empty.
- Lack of gas in the supply channel.

Backfire causes a faint detonation in the Booster Tank and if there is no deoxidizer, the flame will reach the Tank (Fig.5 # 47). To restart the welder you must perform the following operations:

- 1) Turn off the welder.
- 2) Unscrew the safety cap (Fig. 1 # 2).
- 3) Pour liquid deoxidizer into the Booster Tank until it reaches the required level; reassemble and start the welder.

4.10 SAFETY DEVICE

- **Safety cap:** it releases an excess of 2 Bar in overpressure.

4.11 REFILLING FLUX (DEOXIDIZER) LIQUID.

This operation must be performed after 6-8 working hours, when you see that the flame is fading and getting shorter, replace-it.

- 1) Put the flame out.
- 2) Turn off the welder.
- 3) Unscrew the handle knob (Fig. 1 # 8) and remove the Booster Tank (Fig. 1 # 7).
- 4) Pour liquid deoxidizer into the Booster Tank until it reaches the maximum level marked on the outside.
- 5) Reassemble the Booster Tank and tighten the handle knob. Do not over tighten.

- 6) We suggest to refill the flux (deoxidizer) daily for optimal performance and better maintenance.

4.12 REFILLING DEMINERALIZED OR DISTILLED WATER



ATTENTION

When the machine uses up the water it must be refilled. This operation **MUST be performed when the yellow indication light is on (Fig. 1 # 5).**

- 1) Slide the switch (Fig. 1 # 1) to the “=” position.
- 2) With a clean funnel, slowly pour distilled or demineralized water through the filling neck (Fig. 1 # 3) until the red indicator light (Fig. 1 # 6) is illuminated. (Do not add more water than necessary). The generator autonomy of the operation is 6-8 hours when the tanks are full.
- 3) Tighten the safety cap (Fig. 1 # 2). Start the welder for at least 2 minutes or for all the time necessary.

SECTION 5

MAINTENANCE

5.1 GENERALITIES



ATTENTION

Any maintenance operation inside the welder must be performed solely by adequate technicians who have been officially trained.



DANGER

INSIDE THE MACHINE, THERE ARE LIVE COMPONENTS (230 OR 115 VOLT AC), CONTACT WITH THESE PARTS CAN CAUSE ELECTRIC SHOCK.

5.2 EVERY SIX MONTHS

Disconnect the plug from the intake.

Remove the Booster Tank, the handle knob and the gaskets. Remove encrustations from the hole and the round groove underneath the Booster Holder.

We recommend to replace the booster gasket and the handle knob O. ring every six months. (Fig. 5 # 22, 24).

To clean eventual encrustations on the bottom of the Booster Tank and inside the torch proceed as follows:

- 1) Remove the liquid deoxidizer from the Booster Tank, soak it horizontally together with the torch in a container filled with about 6 cm of water.
- 2) Provide boiling for at least 30 minutes time necessary to complete dissolution of encrustations.

5.3 ONCE A YEAR

For optimal performance and safety measures it is necessary to replace the following parts:

- Check valve
- Electrolyte solution
- Torch fireproof rubber hose
- Gasket set

5.4 EVERY FOUR YEARS

Every four years the machine must undergo a complete technical and operational review. Such operation must be performed by the manufacturing firm or by skilled technical personnel.



ATTENTION

The manufacturing firm is not liable for any damage caused by the machine due to lack of review.

NOTE: The tank O.ring MUST be replaced every five (5) years according to the manufacture's specifications.

5.5 PUTTING THE MACHINE OUT OF SERVICE

- 1) Empty the electrolyte and rinse the tank.
- 2) Empty the liquid deoxidizer from the Booster Tank.
- 3) Disassemble the machine components and store them separately, according to the material they are made of.

5.6 SCRAPPING

Hand the materials that can be salvaged to companies specialized in recycling raw materials.

5.7 DISPOSING OF THE ELECTROLYTE

Neutralize it to PH7 by adding hydrochloric acid (and small part of albite in powder) and give disposition to an authorized company that handles toxic waste material.

5.8 DISPOSING DEOXIDIZER LIQUID

It can be regenerated by distillation. Alternatively, it must be handed over to a company specialized in the disposal of toxic products.

5.9 TROUBLE SHOOTING

We list hereunder the most frequent, operational complications, failures, relevant causes, and provide a brief description on how to repair or adjust the equipment in order to guarantee an adequate condition of the equipment in use that respects the manufacturer's parameters. Ensuring proper safety standards are abided by, maintaining functional performance, while keeping the integrity of the warranty guarantee established by the manufacturer.

MALFUNCTION	CAUSE	REMEDY
<p>1) <i>The pointer of the gas supply indicator (Fig.1 # 20) returns back to zero.</i></p>	<ul style="list-style-type: none"> - The burner tip diameter is insufficient. - Obstructions due to scale formation. 	<ul style="list-style-type: none"> - Change the burner tip – see Table 2. - Clean the apparatus See sec. 5.2
<p>2) The flame is faint and elongated, its contours blurred. The flame heating power is insufficient.</p>	<ul style="list-style-type: none"> - The electrolyte has been contaminated by foreign matter, such as methyl alcohol, oil, grease, etc... 	<ul style="list-style-type: none"> - Replace the electrolyte (sec. 5.10.5). - Check the tightness of the valve (sec.5.10.3). - Replace the valve, if necessary (sec. 5.10.4).
<p>3) The flame cannot be lighted or is very short.</p>	<p>Obstructions due to scales or there is a gas leakage in the pneumatic channels (see par. 5.2).</p>	<p>Gas leakage: Do not depressurize the machine and remove the power cable.</p> <p>Start with a brush, spread soapy water all over the fitting and Booster Tank, below the Booster holder (Fig.5 # 7, 9, 17), on the torch hose fittings and torch cones (Fig.1 # 10, 15, 16). If you see bubbles coming up, it means that there is a gas leakage. Replace the safety cap if necessary.</p>

		<p>ATTENTION: the same operation can be performed on the fittings and hoses inside the welder. In this case unplug the welder, for there are live components (230 or 115 Volt AC) inside.</p>
<p>4) The flame is shortened even when the power control is set at maximum value.</p>	<ul style="list-style-type: none"> - The electrolyte has been completed or is contaminated with substances.(Section 5.10.5). - The power circuit board is faulty. - One of the two rectifier diodes (Fig. 5 # 27) is not conducting. 	<ul style="list-style-type: none"> - Change the electrolyte solution. - Substitute the power circuit board (Fig.5 # 19). <p>How to spot the faulty diode:</p> <ol style="list-style-type: none"> 1. Remove the cover (Fig.5 # 32) from the frame. 2. Start the welder and let it work for 5-6 minutes with the flame off and the power control set at the maximum value. 3. Unplug the welder and touch immediately the body of the two rectifier diodes. 4. The temperature of the faulty diode is lower than that of the other diode. <p>How to replace the faulty diode: Spread silicone grease all over the contacts surface of the new diode, mount it and tighten the stop nut underneath using dynamometric wrench set from 0,25 to 0,32 Kgm.</p>
<p>5) When starting the machine the fuse blows out (Fig. 5 # 49).</p>	<ul style="list-style-type: none"> - Faulty Power circuit board. - One of the rectifier diode is short- circuited. - Short- circuit inside the tank (Fig. 5 # 46), due to accidental introduction of a metal object. - Short- circuit of the tank cover (Fig. 5 # 43) with the tank, due to over compression of the cover "OR" (Fig. 5 # 45). 	<p>Substitute the power circuit board</p> <p>How to spot the short- circuit diode:</p> <ol style="list-style-type: none"> 1. Disconnect the terminals of the two diodes (Fig. 5 # 27) from the cooper flat conductors. 2. Using an OHM meter (at OHM 1) measure the resistance between the body and the diode, nominal value of 600-2000 OHM. The defective diode, gives a very low value even if you invert the OHM Meter points. 3. Replace the faulty diode.

	<ul style="list-style-type: none"> - The power transformer (Fig. 5 # 39) is short-circuit. - The fan motor (Fig. 5 # 29) is short- circuited. - There is a leakage in the electric circuit. 	<ol style="list-style-type: none"> 1. Empty the tank (Fig. 5 # 46) and dry accordingly, verify that the anode in (Fig. 5 # 43) and that it is isolated from the cathode (Fig. 5 # 46). 2. Dismount the anode (Fig. 5, and remove the metallic object causing the short- circuit. 3. Verify that the O Ring in (Fig. 5 # 45) is mounted correctly and that the isolators (Fig. 5 # 38) are inserted in such a way that the anode is not in contact with the cathode. 4. If the transformer is short- circuit, substitute the item. 5. Change the ventilator if needed. 6. Verify that the internal cables are isolated or that there is no short-circuit caused by the liquid consumed internally, if so, clean with demineralized water conductors or components damaged. 7. Substitute the diode making sure that special care is taken to put silicone on the surface of the new diode, tighten the diode with parameters of 0,25 – 0,32 Kgm.
<p>6) No gas comes out of the burner tip.</p>	<ul style="list-style-type: none"> - Check valve blocked. - Torch/ burner tip obstructed. - Booster tank obstructed. - Gas leakage in pneumatic channels. 	<ul style="list-style-type: none"> - Replace the check valve. - Clean the apparatus See sec. 5.2. <p>In case of gas leakage, repeat steps REMEDY 3 above.</p>
<p>7) Burner Tip (burns) and Back Flame occurs.</p>	<ul style="list-style-type: none"> - Flame is lit before the pressure arrives at the burner tip. - Burner tip excessively big whilst the the 	<ul style="list-style-type: none"> - Before opening flame, wait approx. 2 minutes to verify that the gas comes out of the burner tip. - Consult Table 2.

	<p>power regulator too low.</p> <ul style="list-style-type: none"> - Turning machine off while leaving the flame mistakenly on. - Unscrew safety cap or booster tank while flame is lit. - Gas leakage in pneumatic channels. 	<ul style="list-style-type: none"> - Always turn flame off before turning machine off. - Turn flame off, before removing booster tank or safety cap. - In case of gas leakage, repeat steps REMEDY 3 above.
<p>8) The flame appears Red or fluctuates.</p>	<ul style="list-style-type: none"> - Flux / deoxidizer is consumed. - Liquid levels are above max limits. - Humidity Accumulation in the torch channel. - Soapy substance internally formed, caused by contamination. 	<ul style="list-style-type: none"> - Substitute with new de-oxidizer. - Remove excessive liquids until reaching the proper indication. - Remove accumulated humidity, dismounting the torch and tubes, drying them. - Empty tank, repeat periodically with water then substitute the electrolyte solution.

5.10 INTERVENTIONS

5.10.1 WHAT TO DO IN ORDER TO SEE IF THE TANK IS SHORT- CIRCUITED

- 1) Disconnect the plug from the correct outlet.
- 2) Remove the screws and remove the two copper conductors (Fig.5 # 50) from the tank cover (Fig. 5 # 43).
- 3) Turn on the machine.

If the fuse blows out: see Trouble shooting sec. 5.9

If, on the contrary, the fuse does not blow out, perform the following operations:

- 1) Empty the electrolyte.
- 2) Disassemble the tank cover in the following order: First remove the hose from fitting (Fig. 5 # 40), then the connectors of the two level sensors (Fig. 5 # 42, 44), paying special attention to the order of the connections, and the four nuts (Fig. 5 # 36).
- 3) Remove any metal object from the tank.

- 4) Replace the tank cover “O.ring” (Fig. 5 # 45), replace the cover insulators (Fig. 5 # 38) if faulty, center the tank cover and make sure that the “O.ring” is positioned properly in its seat.
- 5) Tighten the four nuts first manually and then by using a wrench.
- 6) Connect the hose to the fitting, connect the level sensors and the two copper conductors.
- 7) Refill the tank with electrolyte.

5.10.2 CONTROLLING PRESSURE, ADJUSTING THE VALVE

- 1) Turn off the machine and remove the safety cap (Fig. 5 # 2).
- 2) Fit the pressure gauge on the filler neck (Fig. 1 # 3).
- 3) Unscrew the check valve cap (Fig. 1 # 13).
- 4) Turn the power control knob (Fig. 1 # 4), to the maximum power level.
- 5) Start the welder and wait until the pressure reading on the pressure gauge is stable.
Pressure should be 1.1 Bar.

5.10.3 CHECKING VALVE TIGHTNESS

When the welder is on, the working pressure must be approximately, (1.0- 1.2 Bar). Then, after turning off the welder, check that the pressure reading on the pressure gauge drops to the approx. 0.5 Bar, over 5-6 minutes. If the pressure drop is greater than 0.5 Bar, replace the valve (see. 5.10.4).



ATTENTION

If is very important that the valve is tight, since this enables the machine to maintain a minimum pressure of approx. 0.3 Bar inside the tank, even after several hours. Keep in mind that when the machine is not working, the tank cools down causing a pressure drop. If for some reason there is a total lack of pressure, the methyl alcohol contained in the Booster Tank would be sucked in, thus contaminating the electrolyte.

5.10.4 REPLACING THE VALVE

- 1) Turn off the welder and remove the pressure gauge or safety cap (Fig.5 # 2).
- 2) Unscrew the check valve cap (Fig. 4 ; A # 13).
- 3) Unscrew the threaded disk (Fig. 4; B # 21).
- 4) Remove the valve and relevant “O.ring” from the seat.
- 5) Install the new valve and relevant “O.ring” (Fig. 4; C # 23, 53).
- 6) Tighten the threaded disk 21, the check valve cap 13, and safety cap (Fig.1 # 2).
- 7) Check pressure (sec. 5.10.3).

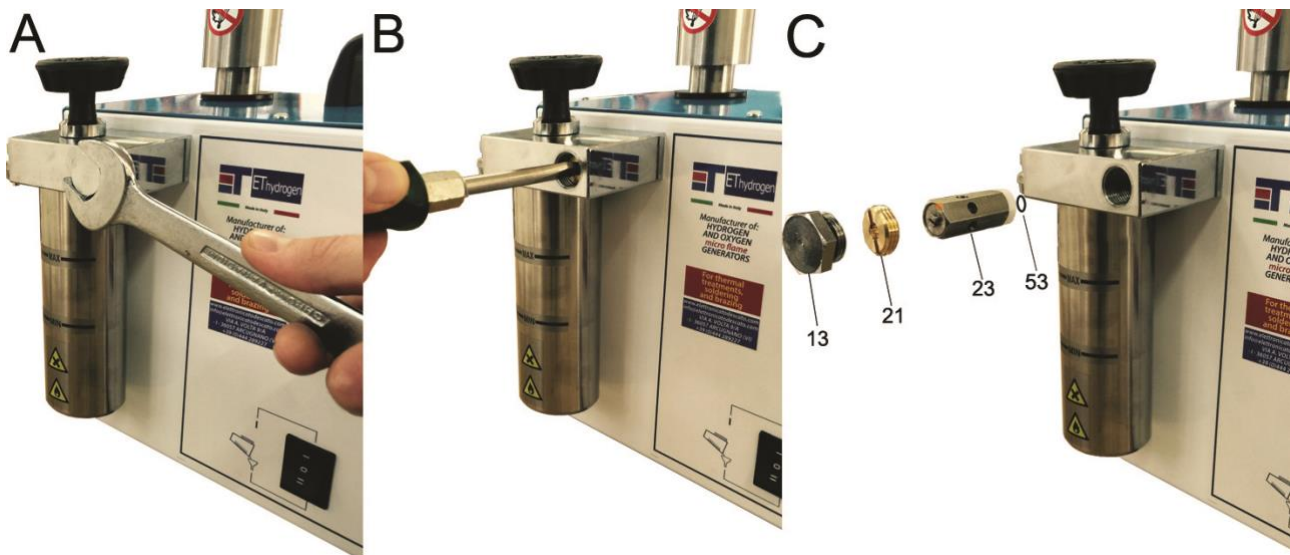

FIG 4 – VALVE REPLACEMENT

5.10.5 REPLACING THE ELECTROLYTE

- 1) Empty the exhausted electrolyte.
- 2) Pour 0,445 Lt (0,118 US gal) of demineralized water into the tank, shake well and empty.
- 3) Repeat this operation until the water that comes out is clean.
- 4) Pour the new electrolyte into the tank (sec. 4.2).

SECTION 6

SPARE PARTS

6.1 SPARE PARTS

Orders for spare parts should be sent to the Manufacturer or Authorized Distributor specifying the following information:

- **Machine Model.**
- **Serial Number.**
- **Year of Fabrication.**
- **Ordering Code Number** for the part required, description of the part and the number required.
- **Shipping Instructions.** If this is not specified by Manufacturer, even though doing its utmost to offer this service as efficiently as possible, cannot and it will not be liable for any shipping delays caused by force majeure events. Transportation costs are always to customer account. Goods travel at buyer peril and risk even if sold carriage forward.

Lastly, the Manufacturer is at your complete disposal for any technical assistance or spare parts needed.

Welder - L/45

INTERNAL VIEW OF COMPONENTS

FIG. 5

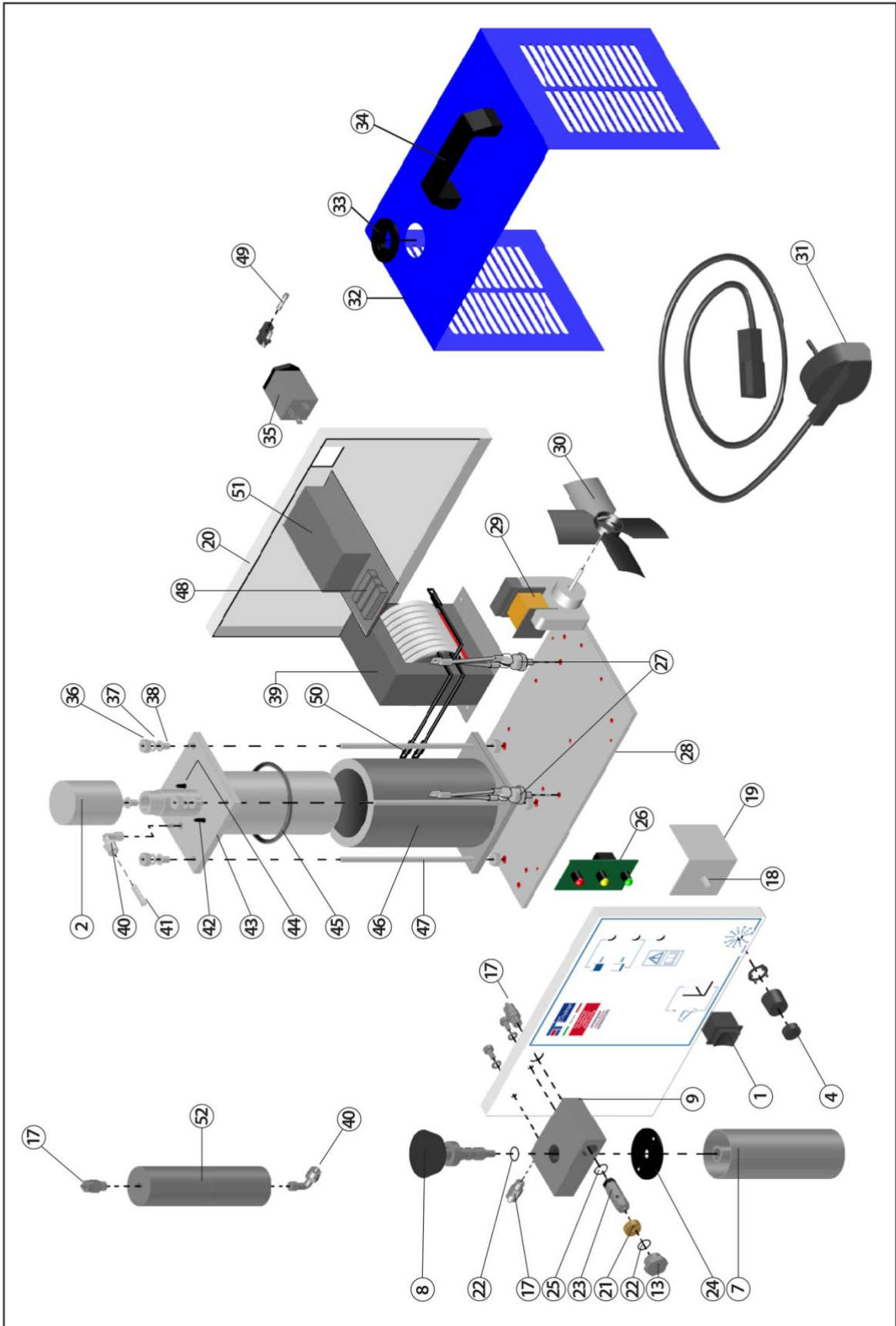

Rif.	Cod.	Description
1	1976	Three position switch
2	1200	Safety cap
3	-	See Fig. 1
4	1050	Power control knob
5	-	See Fig. 1
6	-	See Fig. 1
7	215	Booster Tank
8	540	Handle knob
9	496 – L/45	Booster holder with 1/8" fitting
10	245	Torch (see table 1)
11	1-5-10	Burner tip diameter 0,6-0,7-0,8 mm
12	-	See Fig. 1
13	1195	Check valve cap
14	1118	Torch holder (see table 1)
15	1285	Torch hose 4x6 (see table 1)
16	-	See Fig. 1
17	2945	Fitting 1/8"
18	2606	Front panel
19	360	Power circuit board 230 V.
19	361	Power circuit board 115 V.
20	2607	Rear panel
21	1115	Threaded disk
22	730	Cap and handle knob O. Ring
23	1325	Check valve
24	556	Booster rubber gasket
25	740	Check valve O. Ring
26	141 – 230 V	Level circuit board 230 V.
26	141 – 115 V	Level circuit board 115 V.
27	445	Rectifier diodes
28	811	Alluminum base plate
29	685-700	Fan motor 230 V.-115 V.
30	3476	Fan
31	1930-75-1931	Power cord I-USA-D
32	1877	Cover
33	485	Rubber ring
34	645	Handle
35	1111	Fuse holder plug + RFI Suppression filter
36	353	Nut 6MA
37	116	Washer 6 mm
38	230	Insulator Ø 6 mm
39	1220	Power transformer 230 V.
39	1225	Power transformer 115 V.
40	950	Fitting 1/8" 90°
41	1286	Plastic tube 4x6 mm
42	1176	Minimum level sensor
43	80	Tank cover with anode
44	1177	Maximum level sensor
45	745	Tank O. Ring
46	280	Tank
47	2716	Rod diameter 6 MA
48	1085-1086	Resistor 10 K - 230 V. 2x10 K - 115 V.
49	1396	4 A. (230V.) Fuse
49	1396 – 115 V	8 A. (115 V.) Fuse
50	1220	Power transformer terminal 230 V
50'	1225	Power transformer terminal 115 V
52	966	Separator

Welder - L / 45 **TABLE 6** **WIRING DIAGRAM**

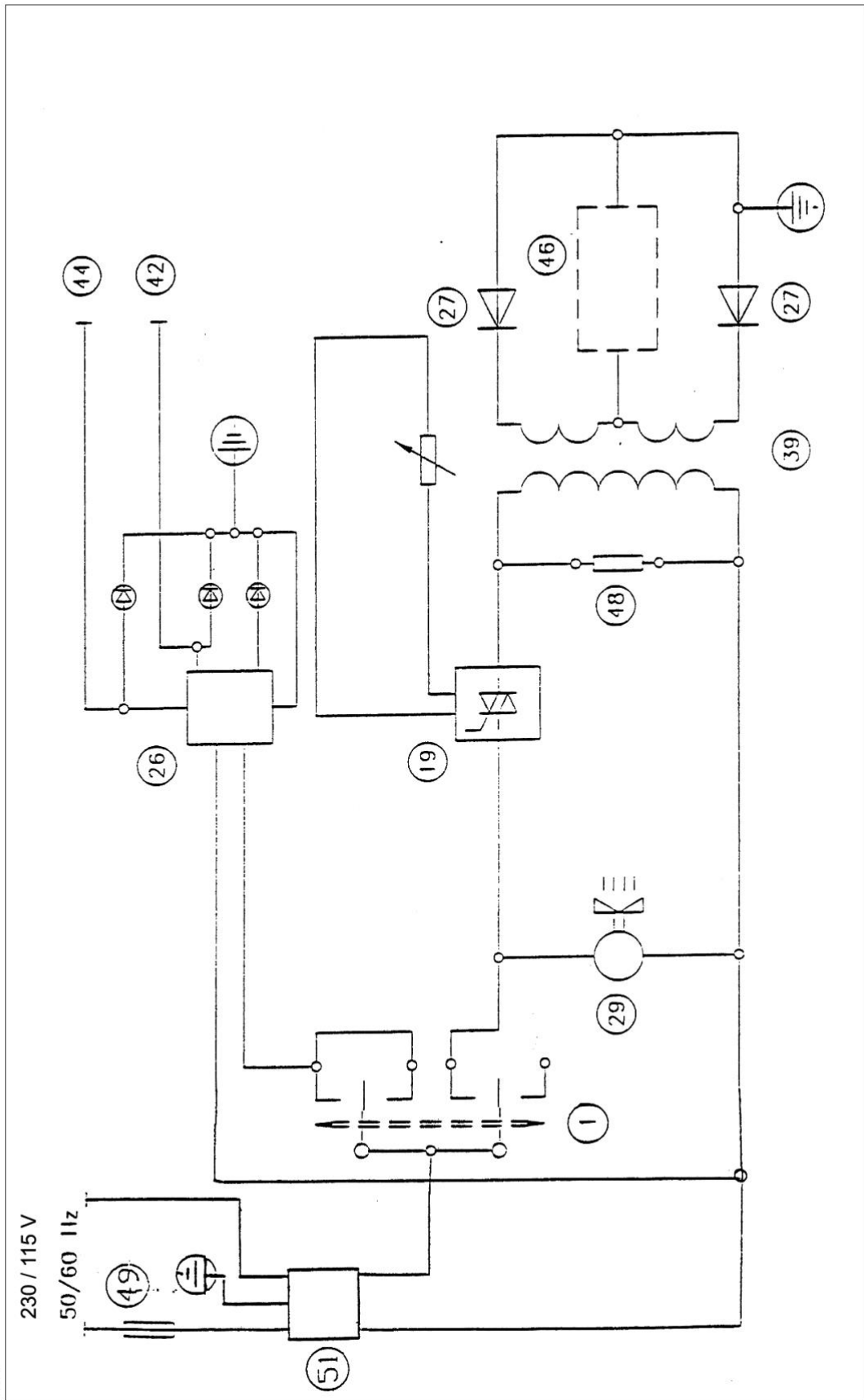

Welder - L /45 **TABLE 7** **GAS CIRCUIT**

